





# Grass Trimmer/Brush Cutter

## *Operator's Manual*

**MODEL,           SRM - 340**  
**Serial Number 03001001 - 03999999**

**WARNING**  **DANGER**

 The muffler or catalytic muffler and surrounding cover may become extremely hot.  
Always keep clear of exhaust and muffler area, otherwise serious personal injury may occur.

 **WARNING** 

The engine exhaust from this product contains chemicals known to the State of California to cause cancer, birth defects or other reproductive harm.



**WARNING**  **DANGER**

Read rules for safe operation and instructions carefully. ECHO provides an Operator's Manual and a Safety Manual. Both must be read and understood for proper and safe operation.

## INTRODUCTION

Welcome to the ECHO family. This ECHO product was designed and manufactured to provide long life and on-the-job dependability. Read and understand this manual and the SAFETY MANUAL you found in the same package. You will find both easy to use and full of helpful operating tips and SAFETY messages.

## THE OPERATOR'S MANUAL

Read and understand this manual before operation. Keep it in a safe place for future reference. Contains specifications and information for operation, starting, stopping, maintenance, storage and assembly specific to this product.

## THE SAFETY MANUAL

Read and understand this manual before operation. Keep it in a safe place for future reference. Explains possible hazards involved with the use of Edgers and the measures you should take to make their use safer.

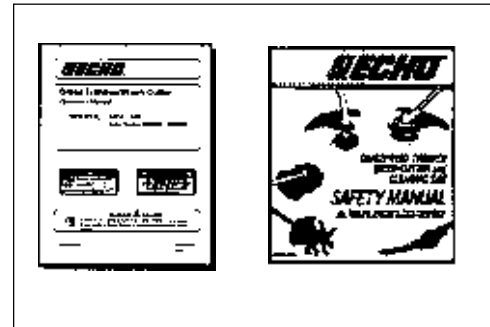

## TABLE OF CONTENTS

Introduction .....	2	- Fuel .....	18
- The Operator's Manual .....	2	Operation .....	19
- The Safety manual .....	2	- Starting Cold Engine .....	19
Manual Safety Symbols and Important Information .....	3	- Starting Warm Engine .....	20
Safety .....	3	- Stopping Engine .....	20
- Decals .....	3	Maintenance .....	21
- International Symbols .....	4	- Skill Levels .....	21
Safety Instructions .....	5	- Maintenance Intervals .....	21
- Personal Condition and Safety Equipment .....	5	- Air Filter .....	22
- Extended Operation/Extreme Conditions .....	5	- Fuel Filter .....	22
- Equipment .....	6	- Spark Plug .....	23
- Safe Operation .....	7	- Cooling System Cleaning .....	23
Emission Control .....	7	- Exhaust System .....	24
Description .....	8	- Carburetor Adjustment Emission .....	25
- Package Contents .....	8	- Lubrication .....	26
- SRM-340 Parts .....	9	- Nylon Line Replacement .....	26
- SRM-340 Part Descriptions .....	10	- Sharpening Metal Blades .....	28
Specifications .....	11	Troubleshooting .....	29
Assembly .....	12	Storage .....	30
- Drive Shaft /Power Head .....	12	Servicing Information .....	32
- Plastic Shield Installation .....	12	- Parts .....	32
- Nylon Head Installation .....	13	- Service .....	32
- Blade Installation .....	13	- ECHO Consumer Product Support .....	32
- Front Handle/Barrier Bar Installation and Adjustment .....	14	- Warranty Card .....	32
- Throttle Linkage and Ignition Leads .....	15	- Additional or Replacement Manuals .....	32
- Balance and Adjust Unit .....	15		
Pre-Operation .....	16		
- Operation with Blades .....	16		

Specifications, descriptions and illustrative material in this literature are as accurate as known at the time of publication, but are subject to change without notice. Illustrations may include optional equipment and accessories, and may not include all standard equipment.

## MANUAL SAFETY SYMBOLS AND IMPORTANT INFORMATION

Throughout this manual and on the product itself, you will find safety alerts and helpful information messages preceded by symbols or key words. The following is an explanation of those symbols and key words.



This symbol accompanied by the words **WARNING** and **DANGER** calls attention to an act or condition that can lead to serious personal injury to operator and bystanders.



The circle with the slash symbol means whatever is shown within the circle is prohibited.

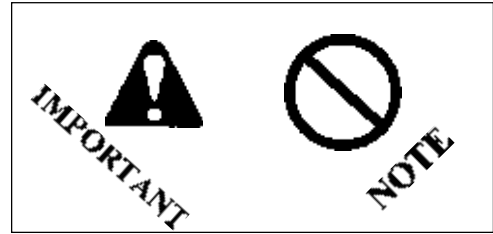

**IMPORTANT** The enclosed message provides information necessary for the protection of the unit.

**NOTE** This enclosed message provides tips for use, care and maintenance of the unit.

## SAFETY

### DECALS

Locate these safety decals on your unit. The complete unit illustration, found in the "DESCRIPTION" section, will help you locate them. Make sure the decals are legible and that you understand and follow the instructions on them. If a decal cannot be read, a new one can be ordered from your ECHO dealer. See PARTS ORDERING instructions for specific information.

### *Shaft Decal* *Spanish Decal*



89017740630

#### ADVERTENCIA PELIGRO

Esta unidad puede ser peligrosa y producir lesiones personales graves si no se usa en forma adecuada. Para reducir el riesgo de lesionarse, los operadores, los ayudantes y los espectadores deben leer y comprender el Manual Del Operador y los Manuales De Seguridad que se entregan escritos en español.

### DEBRIS SHIELD DECAL



Metal Debris  
Shield

### *English Translation*

#### **WARNING DANGER**

This unit can be dangerous and cause serious injury if improperly used. To reduce injury risk to operator, helpers and bystanders, read and understand the Operator's and Safety Manuals, which are provided in Spanish.

## Shaft Decal









P/N 89016054130





**WARNING**  **DANGER**

- This unit can be dangerous and cause serious injury if improperly used. To reduce injury risk to operator, helpers and bystanders, read and understand the Operator's and Safety manuals.
- Blindness can occur from objects that are thrown or ricocheted even with shield in place. Operators, helpers and bystanders must wear ANSI Z87.1 approved eye protection.
- Always wear hearing protection when operating unit.
- Prevent accidental contact with unit and any cutting attachment. Maintain a 15 m (50 ft.) radius, **DANGER ZONE** surrounding the operator. **ONLY** the operator, dressed in proper protective clothing should be in the **DANGER ZONE**.
- Beware of **KICKOUT (blade thrust)** when using blades. Special precautions are necessary for blade operation, see your Operator's and Safety Manuals. **ONLY** install ECHO approved blades on Brush Cutters (SRM) models equipped with proper blade shield, U-handles, harness, blade collar, nut and cotter pin.
- Blade/Cutting attachment does not stop immediately after releasing throttle. Keep hands and feet clear of blade/cutting attachment unless engine is shut off and cutting attachment is not moving.
- **INSPECT BLADES BEFORE USE.**
- **DO NOT USE DAMAGED, CRACKED, BENT, DULL OR IMPROPERLY SHARPENED BLADES.**
- Do not remove shields, modify the unit or install attachments or parts not approved by ECHO. Approved attachment information and replacement Operator's and Safety Manuals are available from your ECHO dealer or by writing: **ECHO, INCORPORATED, 400 OAKWOOD RD., LAKE ZURICH, IL 60047.**

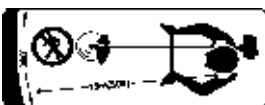

## INTERNATIONAL SYMBOLS

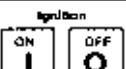
Symbol form/shape	Symbol description/application	Symbol form/shape	Symbol description/application
	"WARNING, SEE OPERATOR'S MANUAL"		Hot Surface
	Wear eyes, ears and head protection		Finger Severing
	Wear hand and foot protection		DO NOT allow flames or sparks near fuel.
	Safety/Alert		DO NOT smoke near fuel.
	Keep bystanders and helpers away 15 m (50 ft.).		

SYMBOL	DESCRIPTION	SYMBOL	DESCRIPTION
	Emergency stop		Fuel and oil mixture
<b>H</b>	Carburetor adjustment - High speed mixture		Primer Bulb
<b>T</b>	Carburetor adjustment - Idle speed		Ignition ON/OFF
<b>L</b>	Carburetor adjustment - Low speed mixture		
	Choke Control "Cold Start" Position (Choke Closed)		Choke Control "Run" Position (Choke Open)

## SAFETY INSTRUCTIONS

### PERSONAL CONDITION AND SAFETY EQUIPMENT

#### WARNING DANGER

Trimmer/Brush Cutter users risk injury to themselves and others if the trimmer/brush cutter is used improperly or safety precautions are not followed. Proper clothing and safety gear must be worn when operating a trimmer.

#### *Physical Condition*

Your judgment and physical dexterity may not be good:

- if you are tired or sick,
- if you are taking medication,
- if you have taken alcohol or drugs.

Operate unit only if you are physically and mentally well.

#### *Eye Protection*

Wear eye protection that meets ANSI Z87.1 or CE requirements whenever you operate the trimmer.

#### *Hand Protection*

Wear no-slip, heavy duty work gloves to improve your grip on the Trimmer/Brush Cutter handles. Gloves also reduce the transmission of machine vibration to your hands.

#### *Hearing Protection*

ECHO recommends wearing hearing protection whenever unit is used.

#### *Proper Clothing*

Wear snug fitting, durable clothing;

- Pants should have long legs, shirts with long sleeves.
- DO NOT WEAR SHORTS,
- DO NOT WEAR TIES, SCARVES, JEWELRY.

Wear sturdy work shoes with non-skid soles;

- DO NOT WEAR OPEN TOED SHOES,
- DO NOT OPERATE UNIT BAREFOOTED.

## EXTENDED OPERATION/EXTREME CONDITIONS

### *Vibration and Cold*

It is believed that a condition called Raynaud's Phenomenon, which affects the fingers of certain individuals may be brought about by exposure to vibration and cold. Exposure to vibration and cold may cause tingling and burning sensations followed by loss of color and numbness in the fingers. The following precautions are strongly recommended because the minimum exposure which might trigger the ailment is unknown.

- Keep your body warm, especially the head, neck, feet, ankles, hands and wrists.
- Maintain good blood circulation by performing vigorous arm exercises during frequent work breaks and also by not smoking.
- Limit the hours of operation. Try to fill each day with jobs where operating the trimmer or other hand-held power equipment is not required.
- If you experience discomfort, redness and swelling of the fingers followed by whitening and loss of feeling, consult your physician before further exposing yourself to cold and vibration.



## ***Repetitive Stress Injuries***

It is believed that overusing the muscles and tendons of the fingers, hands, arms, and shoulders may cause soreness, swelling, numbness, weakness, and extreme pain in those areas. Certain repetitive hand activities may put you at a high risk for developing a Repetitive Stress Injury (RSI). An extreme RSI condition is Carpal Tunnel Syndrome (CTS), which could occur when your wrist swells and squeezes a vital nerve that runs through the area. Some believe that prolonged exposure to vibration may contribute to CTS. CTS can cause severe pain for months or even years.

To reduce the risk of RSI/CTS, do the following:

- Avoid using your wrist in a bent, extended or twisted position. Instead try to maintain a straight wrist position. Also, when grasping, use your whole hand, not just the thumb and index finger.
- Take periodic breaks to minimize repetition and rest your hands.
- Reduce the speed and force with which you do the repetitive movement.
- Do exercises to strengthen the hand and arm muscles.
- Immediately stop using all power equipment and consult a doctor if you feel tingling, numbness, or pain, in the fingers, hands, wrists, or arms. The sooner RSI/CTS is diagnosed, the more likely permanent nerve and muscle damage can be prevented.

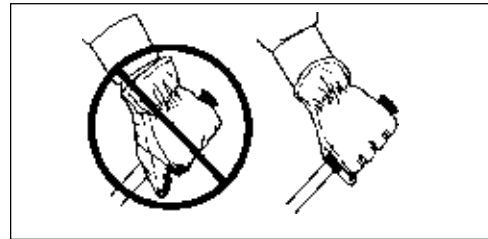

## **EQUIPMENT**

### **WARNING DANGER**

Use only ECHO-approved attachments. Serious injury may result from the use of a non-approved attachment combination. ECHO, INC. will not be responsible for the failure of cutting devices, attachments, or accessories which have not been tested and approved by ECHO. Read and comply with all safety instructions listed in this manual and safety manual.

- Check unit for loose/missing nuts, bolts and screws. Tighten and/or replace as needed.
- Inspect fuel lines, tank, and area around carburetor for fuel leaks. DO NOT operate unit if leaks are found.
- Inspect shield for damage, and ensure that the cut-off knife is securely in place. Replace if either is damaged or missing.
- Check that the cutting attachment is firmly attached and in safe operating condition.
- Check that front loop handle and shoulder strap/ or shoulder/ waist harness are adjusted for safe, comfortable operation. See Assembly Section for proper adjustment.
- Keep exhaust area clear of flammable debris. Avoid contact during and immediately after operation.

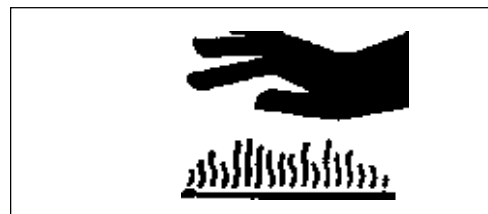

## SAFE OPERATION

### WARNING DANGER

Do not operate this product indoors or in inadequately ventilated areas. Engine exhaust contains poisonous emissions and can cause serious injury or death.

#### **Provide Safety Instructions To All Operators**

- Provide all operators of this equipment with the Operator's Manual and Safety Manual for instructions on safe operation.

#### **Keep A Firm Grip**

- Hold the front and rear handles using both hands, with thumbs and fingers encircling the handles

#### **Keep A Solid Stance**

- Maintain footing and balance at all times. Do not stand on slippery, uneven or unstable surfaces. Do not work in odd positions or on ladders. Do not over reach.



## EMISSION CONTROL

### *EPA Phase 1*

The emission control system for these engines is EM (Engine Modification).

#### IMPORTANT ENGINE INFORMATION

ENGINE FAMILY: 3EHXS.0344RA  
DISPLACEMENT: 34.0 cc  
THIS ENGINE MEETS U.S. EPA PH1 EMISSION  
REGULATIONS FOR SMALL NON ROAD ENGINES.  
REFER TO OWNER'S MANUAL FOR MAINTENANCE  
SPECIFICATIONS AND ADJUSTMENTS.



**An Emission Control Label** is located on the engine. (This is an EXAMPLE ONLY, information on label varies by engine FAMILY).

#### PRODUCT EMISSION DURABILITY

The 300 hour emission durability period is the time span selected by the manufacturer certifying the engine emissions output meets applicable emissions regulations, provided that approved maintenance procedures are followed as listed in the Maintenance Section of this manual.

## DESCRIPTION

Your new Echo product has been factory pre-assembled for your convenience. Due to packaging restrictions, shield installation and other final assembly may be necessary.

Check the contents carefully, and notify your retailer or ECHO Dealer immediately if any parts are missing or damaged. Use the contents list below to check for missing parts.

## PACKAGE CONTENTS

- \_\_\_ 1 Power Head
- \_\_\_ 1 Drive Shaft Assembly w/Gear Housing
- \_\_\_ 1 Front Handle
- \_\_\_ 1 Front Handle Bracket
- \_\_\_ 4 5 mm x 35 mm screws
- \_\_\_ 4 5 mm nuts
- \_\_\_ 1 Nylon Trimmer Head
- \_\_\_ 1 Plastic Debris Shield
- \_\_\_ 1 Shield Plate
- \_\_\_ 3 5 mm x 16 mm screws (Shield Plate-Gear Case)
- \_\_\_ 1 Metal Shield
- \_\_\_ 1 Metal Shield Bracket
- \_\_\_ 3 5 mm x 15 mm screws (Shield-Gear Case)
- \_\_\_ 2 5 mm x 8 mm screws (Bracket-Shield)
- \_\_\_ 4 5 mm nuts (Bracket-Shield & Gear Case)
- \_\_\_ 4 5 mm lockwashers (Bracket-Shield & Gear Case)
- \_\_\_ 1 Standard Shoulder Harness
- \_\_\_ 1 Safety Glasses
- \_\_\_ 1 Echo 2-Stroke Oil
- \_\_\_ 10 2 mm x 25 mm Cotter Pins
- \_\_\_ 1 8 mm x 10 mm Open-end wrench
- \_\_\_ 1 Combination Socket/Screwdriver Tool (Scrench)
- \_\_\_ 1 Locking Tool
- \_\_\_ 1 "4 mm "L" hex wrench"
- \_\_\_ 1 Operator's Manual
- \_\_\_ 1 Safety Manual
- \_\_\_ 1 Warranty Registration Card
- \_\_\_ 1 Limited Warranty Statement
- Safety Video (Recommended)





**MODEL SRM-340 PARTS**

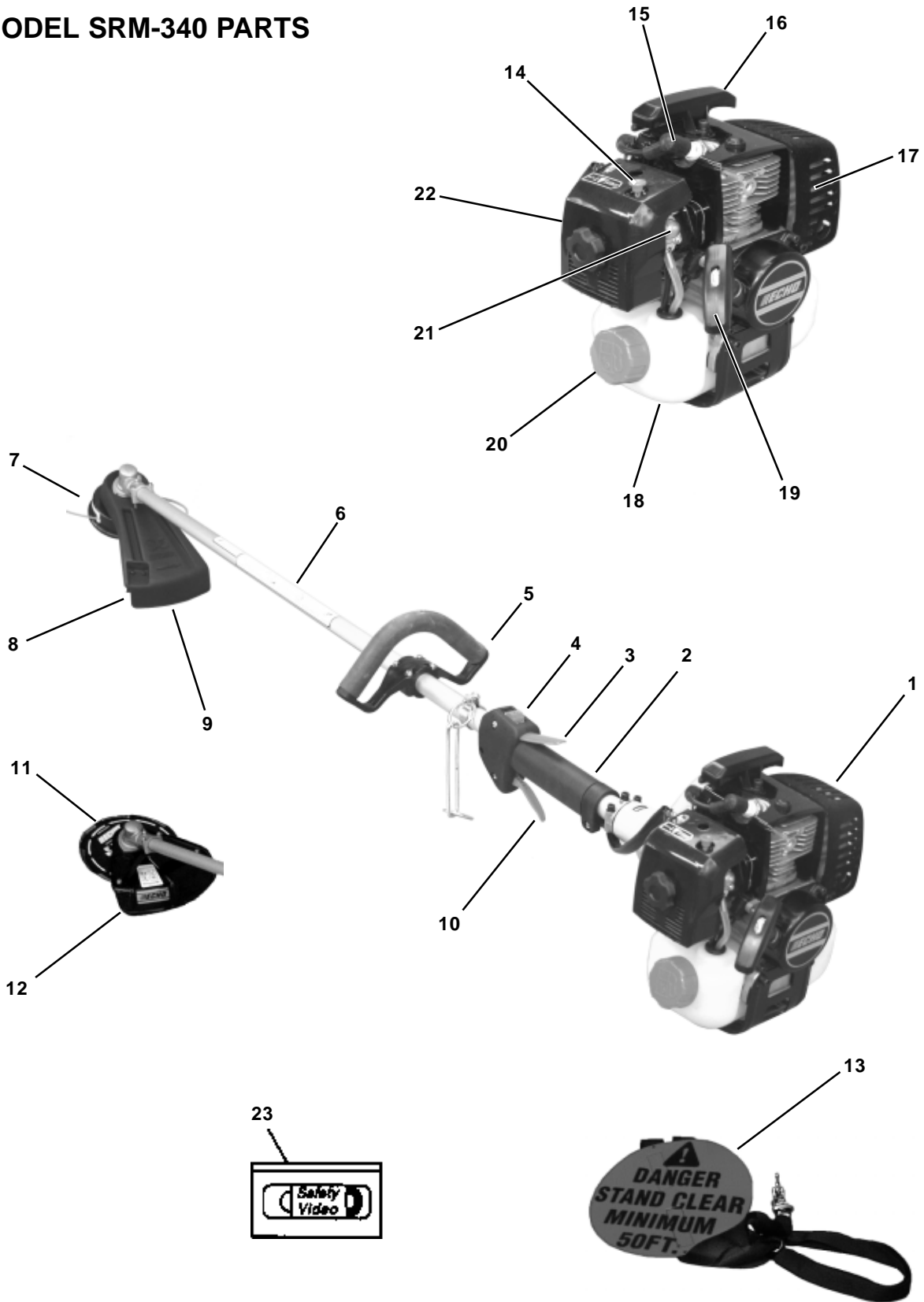

## MODEL SRM-340 PART DESCRIPTIONS

1. **POWER HEAD** - Includes the Engine, Clutch, Fuel System, Ignition System, and Recoil Starter.
2. **GRIP** - Rear (right hand) handle.
3. **THROTTLE TRIGGER LOCKOUT** - This lever must be held during acceleration. Operation of the throttle trigger is prevented unless throttle trigger lockout lever is engaged.
4. **STOP SWITCH** - "SLIDE SWITCH" mounted on top of the Throttle Trigger Housing. Move switch FORWARD to RUN, BACK to STOP.
5. **FRONT HANDLE** - Provides a secure forward grip for holding unit. Must be positioned for proper cutting attitude and operator comfort.
6. **DRIVE SHAFT ASSEMBLY** - Includes the Rear (right hand) Handle assembly, Gear Housing assembly, Blade attachment parts, Drive Shaft, and Safety Decal.
7. **NYLON CUTTING ATTACHMENT** - Contains replaceable nylon trimming line that advances when the trimmer head is tapped against the ground while the head is turning at normal operating speed.
8. **CUT-OFF KNIFE** - Automatically trims line to the correct length (5 in.) after head is tapped on the ground while nylon cutting attachment is turning. If trimmer is operated without a cut-off knife, the line will become too long, the engine will overheat and engine damage may occur.
9. **PLASTIC DEBRIS SHIELD ASSEMBLY** - Deflects debris. **MUST** be installed on unit before Nylon Line Head use (See Assembly Instructions). Shield assembly includes the Cut-Off Knife and Safety Decal. Mounts on the Gear Housing Assembly just above the cutting attachment. Helps protect the operator by deflecting debris produced during the trimming operation. This shield must be replaced with the steel shield for blade use.
10. **THROTTLE TRIGGER** - Controls engine speed. Spring loaded to return to idle when released. During acceleration, press trigger gradually for best operating technique.
11. **BLADES** - Circular steel blades for grass, weeds, or brush cutting applications. (Harness, metal shield, and U-handle required for blade operation.)
12. **METAL BLADE SHIELD** - Required when unit is equipped with blades. Do not operate unit without shield.
13. **SHOULDER HARNESS** - An adjustable shoulder strap that suspends the unit from the operator's shoulder. Using the strap reduces operator fatigue and enhances safety.
14. **CHOKE** - Adjusts Fuel/Air ratio for starting or running engine. The choke control is located at the top of the air filter case. Move choke lever to "Cold Start" (⏏) to close choke for cold starting. Move choke lever to "Run" (⏏) position to open choke.
15. **SPARK PLUG** - Provides spark to ignite fuel mixture.
16. **TOP GUARD** - Protects operator's arm from the hot engine during normal operation.
17. **SPARK ARRESTOR - CATALYTIC MUFFLER/MUFFLER** - The muffler or catalytic muffler controls exhaust noise and emission. The spark arrestor screen prevents hot, glowing particles of carbon from leaving the muffler. Keep exhaust area clear of flammable debris.
18. **FUEL TANK** - Holds fuel and contains the fuel filter.
19. **RECOIL STARTER HANDLE** - Starts engine. Pull handle slowly until starter engages, then quickly and firmly. When engine starts, return handle slowly. DO NOT let handle snap back or damage to unit will occur.
20. **FUEL TANK CAP** - Covers and seals fuel tank opening.
21. **PRIMER BULB** - Primes carburetor for quick starting. Pumping primer bulb before starting engine draws fresh fuel from the fuel tank, priming the carburetor for starting. Pump primer bulb until fuel is visible and flows freely in the clear fuel tank return line. Pump bulb an additional 4 or 5 times.
22. **AIR CLEANER** - Filters out dirt and debris in air. Contains replaceable filter element.
23. **SAFETY VIDEO** - (Not included with unit) P/N 99922202540 English version and P/N 99922203508 Spanish version are available at a cost of \$5.00 from ECHO, INC. or any authorized ECHO dealer. The video overviews safety precautions and proper operating techniques and is supplemental to the Safety Manual. Read and understand the Safety Manual for complete information on safe operation.

## SPECIFICATIONS

<b>MODEL</b> .....	<b>SRM-340</b>
Length .....	1835 mm (72.2 in.)
Width .....	330 mm (13.0 in.)
Height .....	260 mm (10.2 in.)
Weight (dry) w/Cutter Head .....	7.3 kg (16.1 lb.)
Engine Type .....	Air cooled, two-stroke, single cylinder gasoline engine
Bore .....	38.0 mm (1.50 in.)
Stroke .....	30.0 mm (1.18 in.)
Displacement .....	34.0 cc (2.08 cu. in.)
Exhaust .....	Spark Arrestor Muffler
Carburetor .....	Walbro diaphragm model WT w/purge
Ignition System .....	Flywheel magneto, capacitor discharge
Spark Plug .....	NGK BPM-7A, (Gap 0.65 mm (0.026 in.))
Fuel .....	Mixed (Gasoline and Two-stroke Oil)
Fuel/Oil Ratio .....	50:1 ECHO High Performance, two-stroke air cooled engine oil
Gasoline .....	89 Octane unleaded. DO NOT use fuel containing methyl alcohol, more than 10% ethyl alcohol or 15% MTBE.
Oil .....	50:1 ECHO High Performance, two-stroke air cooled engine oil
Fuel Tank Capacity .....	0.8 lit. (27.1 US fl. oz.)
Starter System .....	Automatic Recoil Starter
Clutch .....	Centrifugal Type
Drive Shaft .....	8mm Spline Steel Shaft
Rotating Direction .....	Counter Clockwise viewed from top
Cutter Head .....	Nylon line head (2-line)
Handles* .....	Front-Loop, Right Grip Standard
U-Handle .....	Optional
Shoulder Harness .....	Standard
Idle Speed .....	2500-3300 RPM
Wide Open Throttle Speed (W.O.T.)	
with Nylon Line Head .....	9000-11,000 RPM
Wide Open Throttle Speed (W.O.T.) with Blade .....	9500-11,000 RPM

\* Install and use U-Handle when operating any model with blade.

## ASSEMBLY DRIVE SHAFT/POWER HEAD

*Tools Required:* 4 mm Hex Wrench

*Parts Required:* Power Head, Drive Shaft Assembly

1. Stand power head upright on a level surface.
2. Loosen the two (2) drive shaft clamp bolts at engine drive shaft clamp, and remove center drive shaft location bolt (A).
3. Carefully fit driveshaft assembly to engine making sure that inner drive shaft engages into clutch mount.
4. Turn drive shaft housing until locating hole lines up with location hole in clamp and install center drive shaft location bolt (A).

### NOTE

Gear housing must be aligned properly with engine. Aligning center locating hole in driveshaft housing with center drive shaft bolt (A) provides correct alignment.

5. Tighten two (2) drive shaft clamp bolts (B) securely.

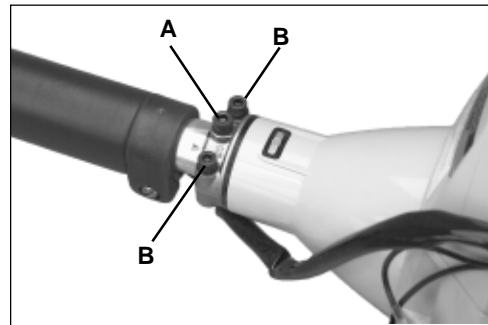
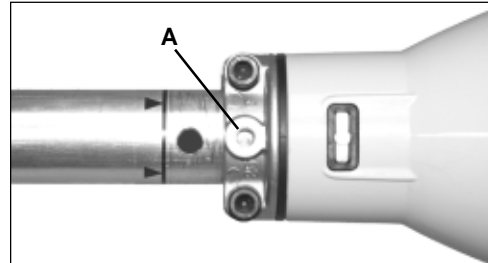

## PLASTIC SHIELD INSTALLATION

*(Nylon line operation)*

*Tools Required:* Screwdriver, Locking Tool

*Parts Required:* Plastic Debris Shield, Shield Plate, three (3) 5 x 16 mm screws.

### WARNING DANGER

The plastic shield is for use with the Nylon Line Head only. Install Metal Shield when using plastic or metal blades, or serious injury may result.

1. Align hole in upper plate (D) with notch in gear housing (G), and insert locking tool to prevent splined shaft from turning. Arrow on gear housing flange points to notch location.
2. Remove cotter pin (A), L.H. blade nut (B), lower plate (C), and upper plate (D) from PTO shaft. Turn blade nut clockwise to remove.
3. Remove locking tool. Retain lower plate, blade nut, and cotter pin for future use with blade conversions.
4. Align plastic debris shield (F) with the drive shaft, and install on the bottom of the gear housing flange.
5. Place shield plate (E) on shield, align holes and install three (3) screws.
6. Replace upper plate (D) on PTO shaft.

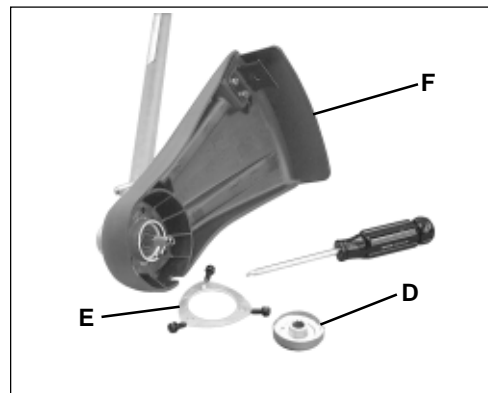
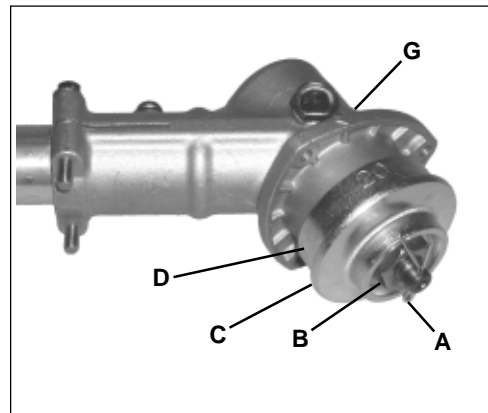

**NYLON HEAD INSTALLATION**

*Tools Required:* Locking Tool, 17x19 mm Srench

*Parts Required:* Nylon Line Head.

1. Make sure plastic debris shield (F) is properly aligned, and upper plate (D) is installed on splined PTO shaft.
2. Align hole in upper plate (D) with notch in gear housing (G), and insert locking tool (H) to prevent splined shaft from turning.
3. Thread line head (I) onto PTO shaft by turning it counter-clockwise until head is tight against upper plate (D).
4. Remove locking tool.

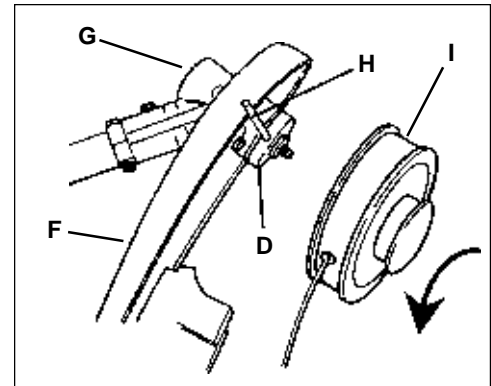

**BLADE OPERATION**

**WARNING  DANGER**

You must install a Barrier Bar or U-Handle Kit and all Blade Conversion parts shown in the following instructions before operating this unit with metal blades, otherwise serious injury may result.

**NOTE**

Model SRM-340 includes necessary blade conversion parts. Blades are not provided with trimmer/brushcutters and must be selected for type of cutting being performed. See page 16, "Choosing The Correct Blade."

***Install Metal Shield***

*Tools Required:* 8 x 10 mm Open-end Wrench, Screwdriver, Srench, Locking Tool

*Parts Required:* Metal Shield, Shield Bracket,  
3 - 5 x 15 mm screws w/captivated flat and lock-washer, (metal shield to gear housing).  
2 - 5 x 8 mm screws, 2 - 5 mm nuts, 2 - 5 mm lock-washers, (bracket to shield).  
2 - 5 mm nuts, 2 - 5 mm lockwashers  
(bracket to gear housing)

1. If installed, remove nylon line head, upper plate and plastic shield, and set upper plate aside for use with blade installation. Retain plastic shield, shield plate, and plastic shield hardware for conversion back to nylon line operation.
2. Align hole in upper plate (D) with notch in gear housing (G), and insert locking tool to prevent splined shaft from turning. Arrow on gear housing flange points to notch location.
3. Remove split pin (A), L.H. blade nut (B), lower plate (C), and upper plate (D) from PTO shaft. Turn blade nut clockwise to remove.
4. Remove locking tool.
5. Loosely attach bracket (J) to shield (K) and attach shield to bottom of gear housing (G) with hardware provided.
6. Tighten all shield hardware.

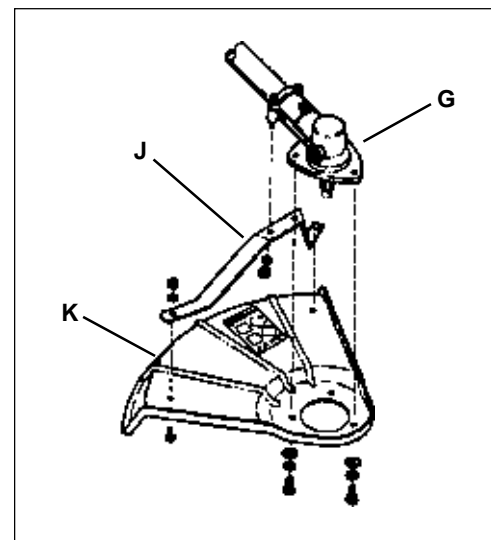
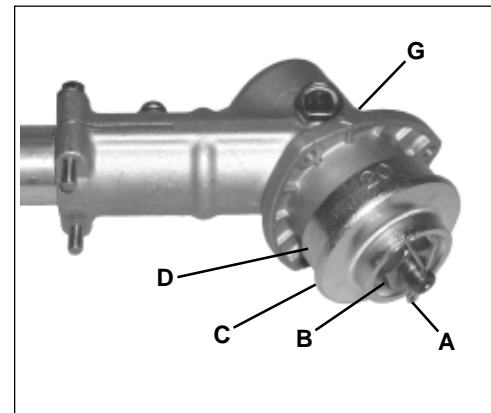

## Install Blade

**Tools Required:** Locking Tool, Scrench.

**Parts Required:** Upper Plate w/ 20 mm pilot, Lower Plate, 10 mm Nut w/L.H. threads, 2 x 25 mm Cotter Pin, Blade.

1. Install upper plate (D) on splined PTO shaft, pilot side down. Blade installation requires Upper Plate (D) with 20 mm pilot.
2. Install Blade (L) on upper plate pilot. Blades must be installed so that rotation arrow on blade matches rotation of unit: teeth toward direction of rotation (See debris shield decal). Secure blade with Lower Plate (C), and 10 mm L.H. nut (B). Turn nut counter-clockwise on PTO shaft to tighten.
3. Align hole in upper plate with notch in gear housing, and insert Locking Tool (H) to prevent splined shaft from turning. Arrow on gear housing points to notch. Tighten 10 mm nut securely.
4. Insert Split Pin (A) in hole in PTO shaft, and bend pin legs around shaft counterclockwise to retain 10 mm nut.

### IMPORTANT

Never reuse a cotter pin - install a new cotter pin each time a blade is installed or replaced.

5. Tri-Cut Blade (M) is installed with Glide Cup (N).
6. Remove locking tool.

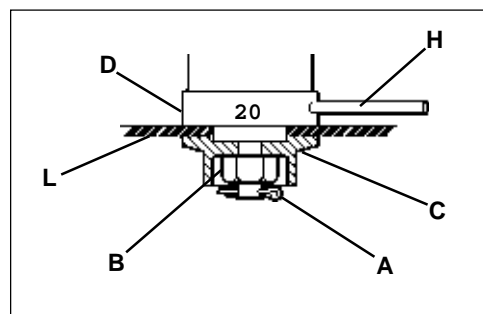
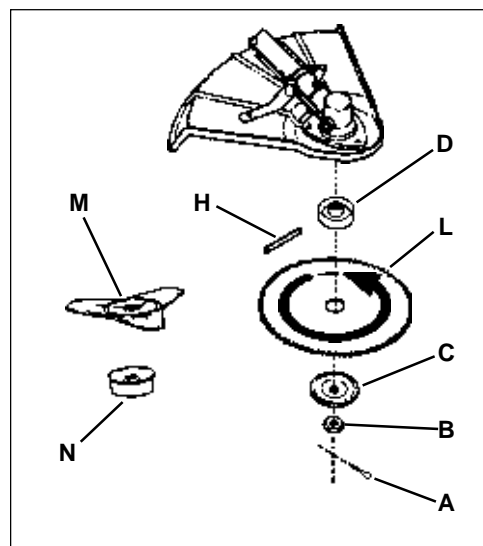

## FRONT HANDLE/BARRIER BAR INSTALLATION AND ADJUSTMENT

**Tools Required:** Screwdriver.

**Parts Required:** Loop Handle Assembly: Loop Handle, Loop Handle Bracket, 5mm x 35mm Screws (4), 5mm Nuts (4)  
Optional: Barrier Bar, P/N 99944200455

### WARNING DANGER

The Barrier Bar must be installed when using grass or weed blades, otherwise serious personal injury may result.

### Handle Only

1. Install loop handle (A) and handle bracket (B) on drive shaft, and position for comfortable operation. Tighten screws.

### Handle and Barrier Bar

1. Install loop handle (A) and barrier bar (C) on drive shaft, and position for comfortable operation. Tighten screws.

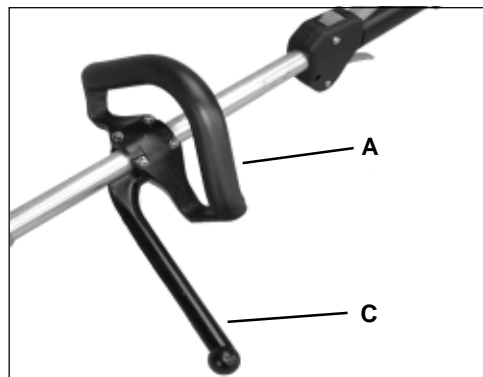
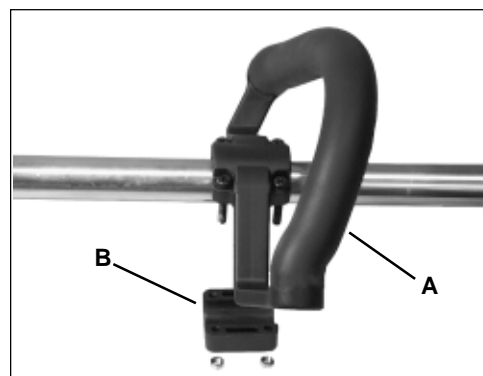

## THROTTLE LINKAGE AND IGNITION LEADS

*Tools Required:* 8 x 10 mm Open-end Wrench

*Parts Required:* Cable Clips

1. Unscrew air filter cover knob and remove cover.
2. Place inner throttle cable in slot of carburetor swivel (B).
3. Loosen nut (A) and place threaded end of throttle linkage on carburetor. Finger tighten nut (A).
4. Check throttle for freedom of movement and that wide open throttle / low idle extremes are adjusted properly. If adjustment cannot be achieved with adjusting nuts, consult with your Echo Dealer for correct adjustment procedure.
5. Tighten nut (A). Connect 2 ignition leads from throttle cable tubing to 2 ignition leads (C) on engine. Gather ignition wires and position behind air filter case.
6. Install air filter and cover.

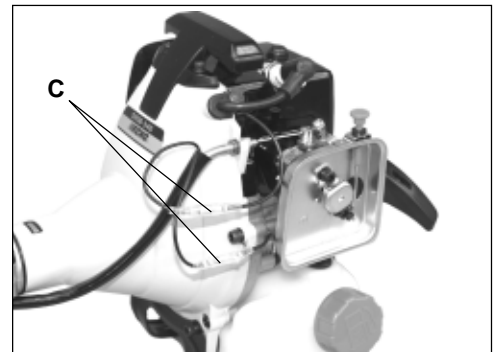
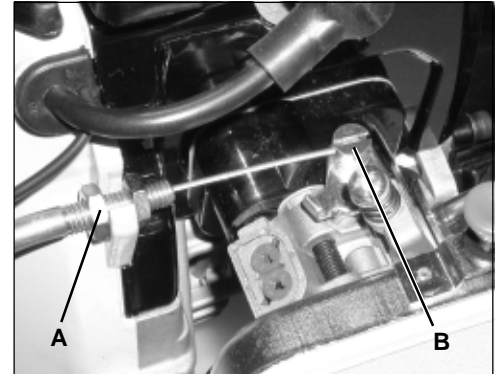

## BALANCE AND ADJUST UNIT

1. Loosen harness clamp screw.
2. Put on harness and attach unit to harness.
3. Slide harness clamp up (A) or down until unit balances with head approximately 50-75 mm (2-3 in.) from the ground.
4. Tighten harness clamp screw.
5. Loosen upper U-Handle clamp screws (B), and position U-Handle for comfortable operation.
6. Tighten U-Handle clamp screws and 8 mm clamp bolt securely.

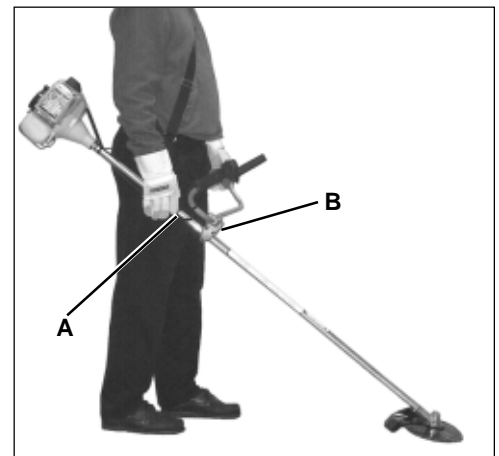

## PRE - OPERATION OPERATION WITH BLADES

### *Preparing the Trimmer/Brush Cutter for Blade Use*

#### WARNING DANGER

Blade use **DEMANDS** specific Trimmer/Brush Cutter configuration. Operation without specified shield, handle, and harness can result in serious personal injury.

#### *Grass/Weed Blades require:*

Installation of metal shield (A), accessory Barrier Bar (B) P/N 99944200455, and use standard harness (C).

#### NOTE

The Barrier Bar is **NOT A HANDLE** and should not be gripped when using or carrying the unit.

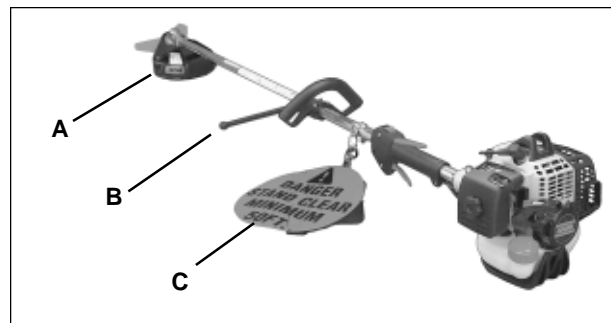

#### *Brush/Clearing Blades require:*

Installation of metal shield (A), U-Handle Kit (D), P/N 35130455830, and use harness with hip pad (E).

#### NOTE

Model SRM-340 includes Metal Shield, Standard Harness, and blade mounting hardware.

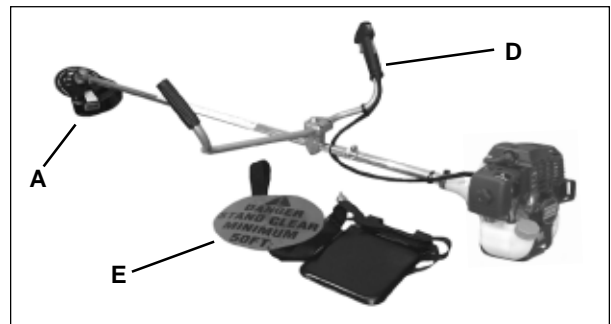

#### NOTE

The Barrier Bar is used to restrict rearward movement of the unit. For heavy-duty or extended use, U-handles should be used. See your Echo dealer or Trimmer/Brush Cutter Safety Manual for details regarding U-Handles. If you have additional questions, contact your Echo Service Dealer, or call Echo directly at 1-800-673-1558.

### *Choosing the Correct Blade*

#### WARNING DANGER

The type of Blade used **MUST** be matched to the type and size of material cut. An improper or dull blade can cause serious personal injury. Blades **MUST** be sharp. Dull blades increase the chance of kickout and injury to yourself and bystanders.



**Plastic/Nylon Grass/Weed Blades** may be used where ever the nylon line head is used. DO NOT use these blades for heavy weeds or brush!



**8 Tooth Grass Weed Blade** - use for grass, garden vegetation, and thick weeds. DO NOT use this blade for brush or heavy woody growth, 19 mm (3/4 in.) diameter or larger. SRM-340Series P/N 69600121431

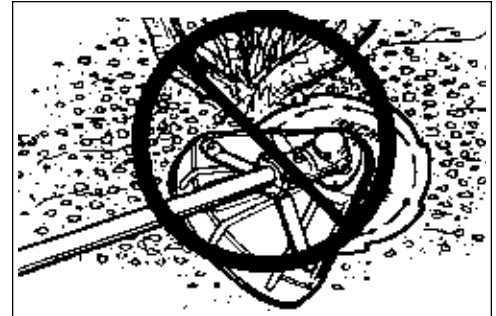

**80 Tooth Brush Blade** - use for cutting brush and woody growth up to 64 mm (2-1/2 in.) diameter. SRM-340Series P/N 69500121431



**22 Tooth Clearing Blade** - use for dense thickets and saplings up to 64 mm (2-1/2 in.) diameter. SRM-340Series P/N 99944200130

**Shoulder/Waist Harness** (P/N 30100052131) Use of the Shoulder/Waist Harness is required for blade operation, and is recommended for **ALL** Trimmer/Brush Cutter use.



The Shoulder/Waist Harness suspends the trimmer from the operator's shoulder, and reduces operator fatigue during nylon line trimming or cutting with a blade.

Operator safety is also enhanced by restricting trimmer movement and preventing blade or line contact with the operator's hands and feet during operation.

**NOTE**

In case of Emergency, the trimmer/brushcutter can be released from the the harness by pulling up on the quick-release collar.

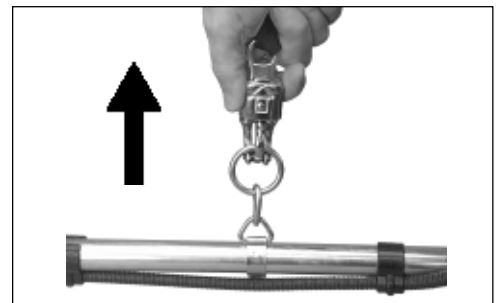

## FUEL

### *Fuel Requirements*

**Gasoline** - Use 89 Octane [(R + M)/2] (mid grade or higher) gasoline known to be good quality. Gasoline may contain up to 15% MTBE (methyl tertiary-butyl ether). Gasohol containing methyl (wood) alcohol is **NOT** approved.

**Two Stroke Oil** - A two-stroke engine oil meeting ISO-L-EGD (ISO/CD 13738) and J.A.S.O. FC Standards, must be used. Echo brand Premium 50:1 oil meets these standards. Engine problems due to inadequate lubrication caused by failure to use an ISO-L-EGD and J.A.S.O. FC certified oil, such as Echo Premium 50:1 Two-stroke Oil, will void the two-stroke engine warranty. (Emission related parts only are covered for two years, regardless of two-stroke oil used, per the statement listed in the Emission Defect Warranty Explanation.)

#### **IMPORTANT**

Echo Premium 2-Stroke Oil may be mixed at 50:1 ratio for application in all Echo engines sold in the past regardless of ratio specified in those manuals.

### Mixing Instructions

1. Fill an approved fuel container with half of the required amount of gasoline.
2. Add the proper amount of 2-stroke oil to gasoline.
3. Close container and shake to mix oil with gasoline.
4. Add remaining gasoline and remix.
5. Install fuel container cap and wipe any spilled fuel from container and surrounding area.

### Handling Fuel

#### **WARNING** **DANGER**

Fuel is **VERY** flammable. Use extreme care when mixing, storing or handling, otherwise serious personal injury may result.

- Use an approved fuel container.
- **DO NOT** smoke near fuel.
- **DO NOT** allow flames or sparks near fuel.
- Fuel tanks/cans may be under pressure. Always loosen fuel caps slowly allowing pressure to equalize.
- **NEVER** refuel a unit when the engine is **HOT!**
- **NEVER** refuel a unit with the engine running.
- **DO NOT** fill fuel tanks indoors. **ALWAYS** fill fuel tanks outdoors over bare ground.
- Securely tighten fuel cap after refueling.
- Inspect for fuel leakage. If fuel leakage is found, do not start or operate unit until leakage is repaired.

#### **IMPORTANT**

Spilled fuel is a leading cause of hydrocarbon emissions. Some states may require the use of automatic fuel shut-off containers to reduce fuel spillage. Contact your ECHO dealer for ordering information.

### *After Refueling*

- Wipe any spilled fuel from the unit.
- Move at least 3 m (10 ft.) from refueling location before starting.

### *After Use*

- **DO NOT** store a unit with fuel in its tank. Leaks can occur. Return unused fuel to an approved fuel storage container.

### *Storage*

Fuel storage laws vary by locality. Contact your local government for the laws affecting your area. As a precaution, store fuel in an approved, air tight container. Store in a well ventilated, unoccupied building, away from sparks and flames. Do not store fuel longer than 30 days.

#### **IMPORTANT**

Stored fuel ages. Do not mix more fuel than you expect to use in thirty (30) days, ninety (90) days when a fuel stabilizer is added.

#### **IMPORTANT**



Stored two-stroke fuel may separate. **ALWAYS** shake fuel container thoroughly before each use.

## OPERATION

### STARTING COLD ENGINE

#### WARNING DANGER

The cutting attachment should not rotate at idle. If attachment rotates, readjust carburetor according to "Carburetor Adjustment" instructions in this manual or see your ECHO Dealer, otherwise serious personal injury may result.

1. *Stop Switch*  
Move stop switch button (A) forward, away from the STOP position.
2. *Choke Lever*  
Move choke lever (B) to Cold Start () Position.
3. *Primer Bulb*  
Pump primer bulb (C) until fuel is visible and flows freely in the clear fuel tank return line. Pump bulb an additional 4 or 5 times.
4. *Recoil Starter*  
Lay the trimmer on a flat, clear area and pull the recoil starter handle (D) until engine fires (5 pulls maximum).
5. *Choke Lever*  
After engine fires, move choke lever to Run () position and pull recoil starter handle/rope (D) until engine starts and runs. Allow unit to warm up at idle for several minutes.

#### NOTE

If engine does not start with choke in "Run" position after 5 pulls, repeat instructions 4 and 5.

6. *Throttle Trigger*  
After engine warm-up, gradually depress throttle trigger to increase engine RPM to operating speed.

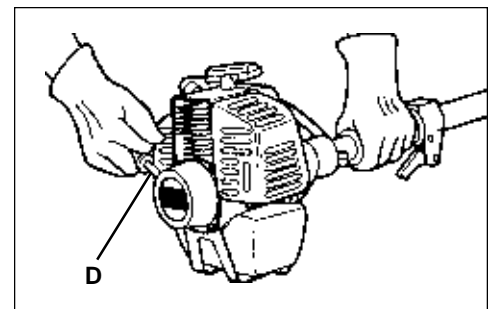
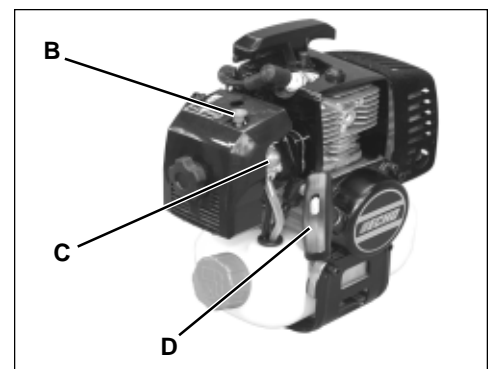
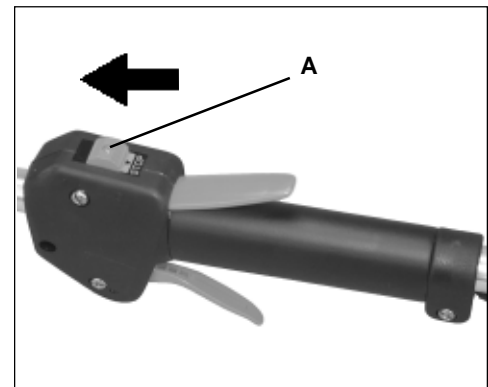

## STARTING WARM ENGINE

### WARNING DANGER

The cutting attachment should not rotate at idle. If attachment rotates, readjust carburetor according to "Carburetor Adjustment" instructions in this manual or see your ECHO Dealer, otherwise serious personal injury may result.

1. *Stop Switch*  
Move stop switch button (A) away from the STOP position.
2. *Recoil Starter*  
Lay the unit on a flat clear area and pull the recoil starter handle (D) until the engine fires.

### NOTE

If engine does not start after 5 pulls, use Cold Start Procedure.

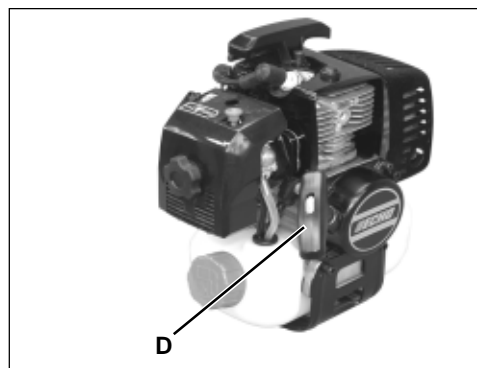
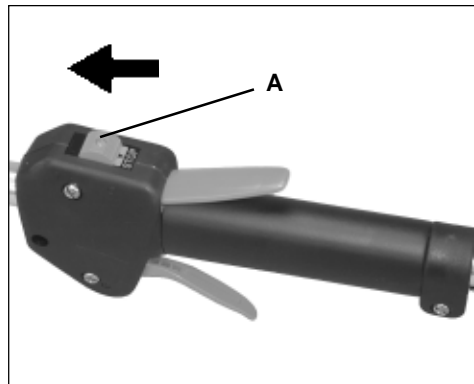

## STOPPING ENGINE

1. *Release Throttle.*  
Allow engine to return to idle before shutting off engine.
2. *Stop Switch.*  
Move stop switch button backward to STOP position.

### WARNING DANGER

If engine does not stop when stop switch is moved to "STOP" position, move choke lever to closed "Cold Start" position to stall engine. Have your ECHO dealer repair stop switch before using trimmer again.

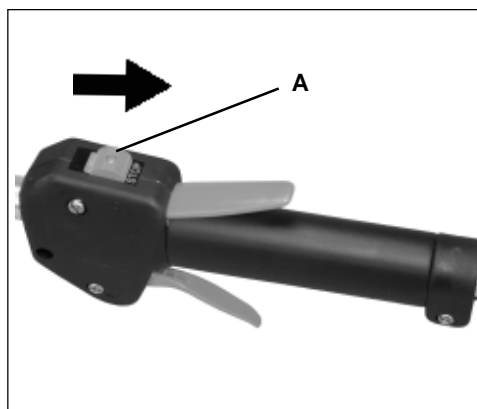

## MAINTENANCE

Your ECHO trimmer is designed to provide many hours of trouble free service. Regular scheduled maintenance will help your trimmer achieve that goal. If you are unsure or are not equipped with the necessary tools, you may want to take your unit to an ECHO Service Dealer for maintenance. To help you decide whether you want to DO-IT-YOURSELF or have the ECHO Dealer do it, each maintenance task has been graded. If the task is not listed, see your ECHO Dealer for repairs

### SKILL LEVELS

- Level 1**= Easy to do. Most required tools come with unit.
- Level 2**= Moderate difficulty. Some specialized tools may be required.
- Level 3**= Experience required. Specialized tools are required. ECHO recommends that the unit be returned to your ECHO dealer for servicing.

ECHO offers **REPOWER™** Maintenance Kits and Parts to make your maintenance job easier. Below each task heading are listed the various part numbers required for that task. See your ECHO dealer for these parts.

### MAINTENANCE INTERVALS

COMPONENT/ SYSTEM	MAINTENANCE PROCEDURE	REQ'D SKILL LEVEL	DAILY OR BEFORE USE	EVERY REFUEL	3 MONTHS OR 90 HOURS	6 MONTHS OR 270 HOURS	YEARLY 600 HOURS
<b>Recommended Echo Dealer Maintenance Procedures</b>							
Carburetor	Inspect/Clean/Replace	<b>3</b>				<b>I / C (1)</b>	<b>R (1)</b>
Cylinder Exhaust Port	Inspect/Clean/Decarbon	<b>3</b>			<b>I / C</b>		
<b>Do-It-Yourself Maintenance Procedures</b>							
Air Filter	Inspect/Clean/Replace	<b>1</b>	<b>I / C</b>		<b>R*</b>		
Choke	Inspect/Clean	<b>2</b>	<b>I / C</b>				
Fuel Filter	Inspect/Replace	<b>1</b>			<b>I</b>		<b>R *</b>
Fuel Line	Inspect/Replace	<b>1</b>	<b>I *</b>	<b>I</b>			
Cooling System	Inspect/Clean	<b>2</b>	<b>I / C</b>				
Muffler Spark Arrestor	Inspect/Replace	<b>2</b>			<b>I *</b>		
Gear Housing	Grease	<b>2</b>			<b>I (2)</b>		
Recoil Starter Rope	Inspect/Clean	<b>1</b>	<b>I / C *</b>				
Fuel Leaks	Inspect	<b>1</b>	<b>I *</b>	<b>I *</b>			
Spark Plug	Inspect/Clean	<b>2</b>			<b>I / C</b>	<b>R *</b>	
Screws/Nuts/Bolts	Inspect/Tighten/Replace	<b>1</b>	<b>I / R *</b>				

**MAINTENANCE PROCEDURE LETTER CODES: I = INSPECT, R = REPLACE, C = CLEAN**

**IMPORTANT NOTE** - Time intervals shown are maximum. Actual use and your experience will determine the frequency of required maintenance.

**MAINTENANCE PROCEDURE NOTES:**

**(1)** Replacement will be required for Commercial use after 600 hours. For Consumer use, cleaning every 6 months is required.

**(2)** Apply ECHO® LUBE™ every 50 hours

\* All recommendations to replace are based on the finding of damage or wear during inspection..

## AIR FILTER

### Level 1.

*Tools required:* 25-50 mm (1 or 2 in.) medium bristle paint brush.

*Parts required:* 90030REPOWER™ AIR & FUEL FILTER KIT.

1. Close choke (Cold Start Position). This prevents dirt from entering the carburetor throat when the air filter is removed. Brush accumulated dirt from the air cleaner area.
2. Remove the air cleaner cover. Clean and inspect the element for damage. If element is fuel soaked or very dirty, replace.
3. If element can be cleaned and reused, be certain it:
  - still fits the cavity in the air cleaner cover.
  - is installed with the original side out.

#### NOTE

Carburetor adjustment may be needed after air filter cleaning/  
replacement.

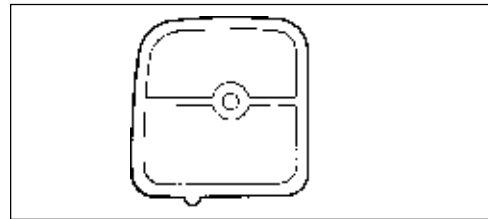

## FUEL FILTER

### Level 1.

*Tools required:* Fuel line hook. 200-250 mm (8 - 10 in.) length of wire with one end bent into a hook. Clean rag, funnel, and an approved fuel container.

*Parts required:* 90030REPOWER™ AIR & FUEL FILTER KIT.

#### WARNING DANGER

Fuel is **VERY** flammable. Use extreme care when mixing, storing or handling.

1. Use a clean rag to remove loose dirt from around fuel cap and empty fuel tank.
2. Use the “fuel line hook” to pull the fuel line and filter from the tank.
3. Remove the filter from the line and install the new filter.



## SPARK PLUG

### Level 2.

*Tools Required:* Srench (combination socket wrench & screw driver)  
Feeler gauge, preferably a wire gauge. Brush.

*Parts Required:* Spark Plug, NGK BPM-7A

1. Remove spark plug and check for wear or fouling.
2. Clean the plug or replace with a new one. DO NOT sand blast to clean. Remaining sand will damage engine.
3. Adjust spark plug gap by bending outer electrode.
4. Install spark plug and tighten to 145-155 kg/cm (125-135 in. lb.).

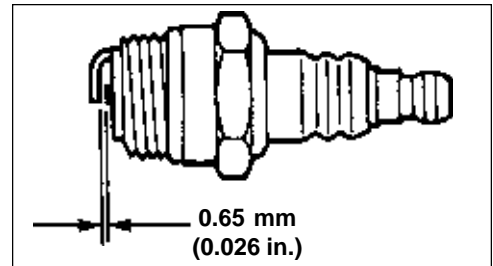
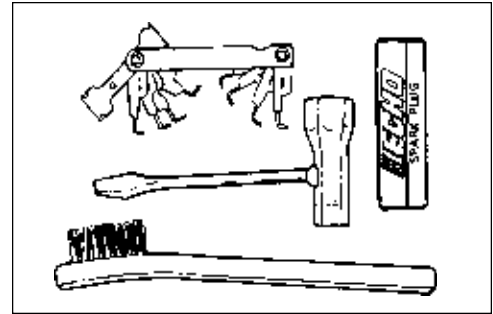

## COOLING SYSTEMS CLEANING

### Level 2.

*Tools required:* Pointed Wood Stick, 25-50 mm (1-2 in.) medium bristle paint brush.

*Parts Required:* No parts are required if care is used during cleaning.

#### **IMPORTANT**

To maintain proper engine operating temperatures, cooling air must pass freely through the cylinder fin area. This flow of air carries combustion heat away from the engine.

Overheating and engine seizure can occur when:

- Air intakes are blocked, preventing cooling air from reaching the cylinder.
- Dust and grass build-up on the outside of the cylinder. This build up insulates the engine and prevents the heat from leaving.

Removal of cooling passage blockages or cleaning of cooling fins is considered "Normal Maintenance." Any failure attributed to lack of maintenance is not warranted.

1. Disconnect spark plug lead from spark plug.
2. Remove three (3) screws from muffler cover, and remove cover.
3. Use the wooden stick or brush to remove dirt from the cylinder fins and muffler area.

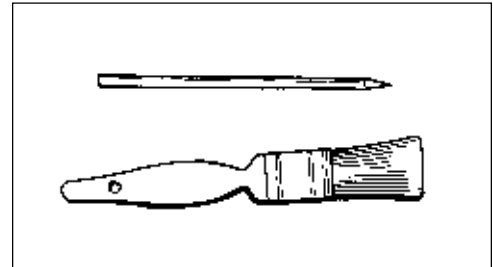

4. Remove grass and leaves from the grid between the recoil starter and fuel tank.
5. Position cover over muffler, and secure with three (3) screws.
6. Connect spark plug lead to spark plug.

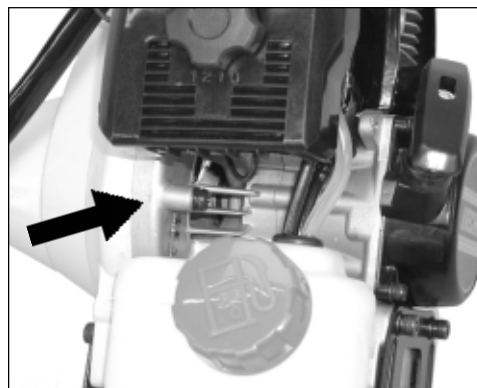

## EXHAUST SYSTEM

### *Spark Arrestor Screen*

#### Level 2.

*Tools Required:* Cross Head Screwdriver, Soft metal brush, Wooden carbon scraper, 4 mm Hex Wrench

*Parts Required:* Screen P/N 14590555730  
Gasket P/N 14586655730

1. Remove three (3) screws from muffler cover (A) and remove.
2. Remove screen holder (B), gasket (C) and screen (D) from muffler body.
3. Clean carbon deposits from muffler components.
4. Replace screen if it is cracked, plugged or has holes burned through.
5. Reassemble in reverse order of removal. Make sure screen is positioned properly before tightening screws.

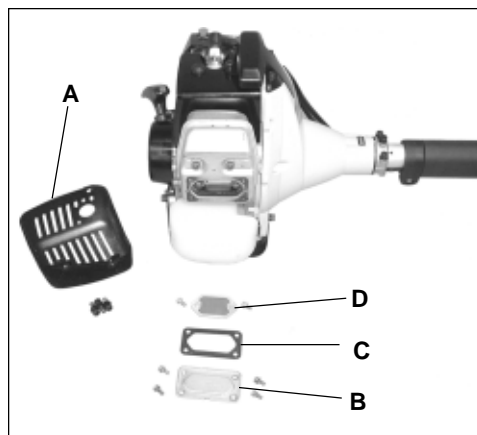
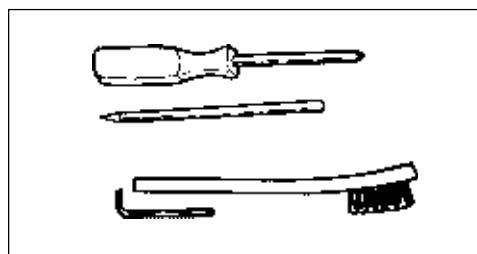



## CARBURETOR ADJUSTMENT

### Level 2.

*Tools required:* Screwdriver, Tachometer (ECHO P/N 99051130017).

*Parts required:* None.

#### NOTE

Every unit is run at the factory and the carburetor is set in compliance with emission regulations. In addition, the carburetor is equipped with HI and LO needle adjustment limiters that prevent settings outside acceptable limits.

1. Before adjusting the carburetor, clean or replace the air filter and spark arrester screen.
2. Trimmer line must be extended to the cut-off knife.
3. Start engine and run for several minutes to reach operating temperature.
4. Stop engine. Turn HI speed needle (A) CCW (counter clockwise) to stop. Turn LO speed needle (B) midway between full CCW and CW (clockwise) stops.
5. Idle Speed Adjustment.
  - Start engine and turn idle speed adjustment screw (C) CW until the cutting attachment begins to turn, then turn the screw CCW until attachment stops turning. Turn screw (C) CCW an additional 1/4 turn.
6. Accelerate to full throttle for 2-3 seconds to clear excess fuel from engine then return to idle. Accelerate to full throttle to check for smooth transition from idle to full throttle. If engine hesitates, turn LO needle (B) CCW an additional 1/8 turn and repeat acceleration. Continue adjusting until smooth acceleration results.
7. Check HI speed RPM at W.O.T. (Wide Open Throttle). HI speed RPM should be set to the specifications found on Page 11 "Specifications" of this manual for the type of cutting attachment on this unit.
8. Check idle speed and reset if necessary. If a tachometer is available, idle speed should be set to the specifications found on page 11 "Specifications" of this manual.

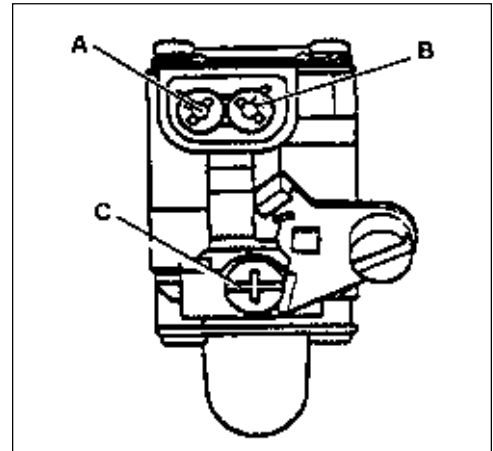
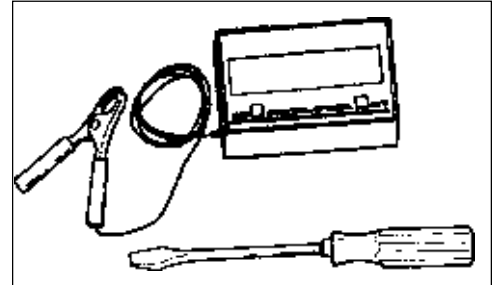

### WARNING DANGER

When carburetor adjustment is completed, the cutting attachment should not turn at idle, otherwise serious personal injury may result.

## LUBRICATION

### Level 1.

*Tools Required:* 8 mm Open-end Wrench, Screwdriver, Clean Rag.

*Parts Required:* ECHO® LUBE™ 8 oz. (P/N 91014) or Lithium Base Grease.

### *Gear Housing*

1. Clean all loose debris from gear box.
2. Remove plug (A) and check level of grease.
3. Add grease if necessary. DO NOT over fill.

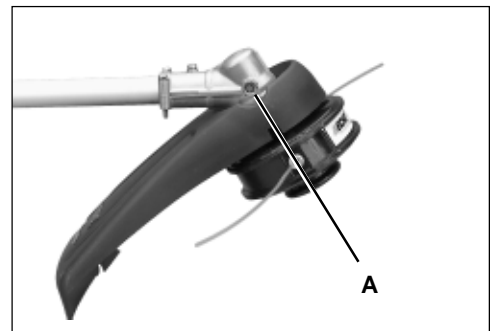

## NYLON LINE REPLACEMENT

### Level 1

*Tools Required:* None

*Parts Required:* ECHO 0.105 in. Nylon Trimmer Line 15 m (50 feet) long.

1. Shut engine off. Lay unit on the ground with head assembly up.
2. Hold head firmly and push in cover tabs (A) to remove cover (B) and spool (C).

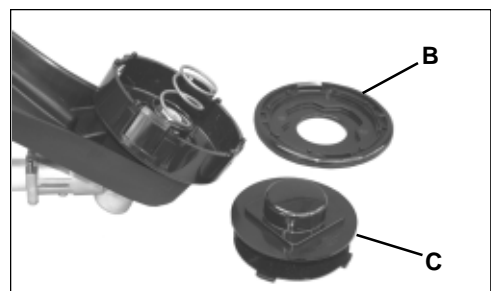
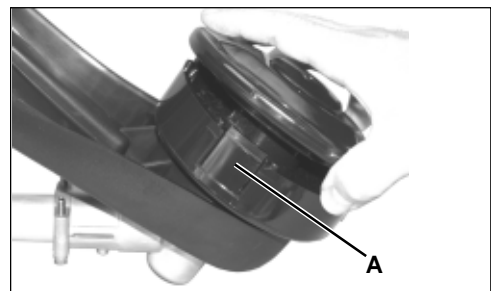

3. Use one piece of nylon line (D) and thread through the molded loop (E) on the spool spindle until ends are even.

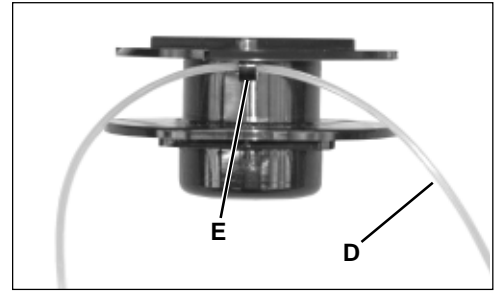

4. Hold spool with the tap knob in your hand and opening toward you. Place index finger between the two lines, and wind line clockwise tightly and evenly.



5. When approximately 15-20 cm (6-8 in.) of line remains, place lines in spool notches (F).

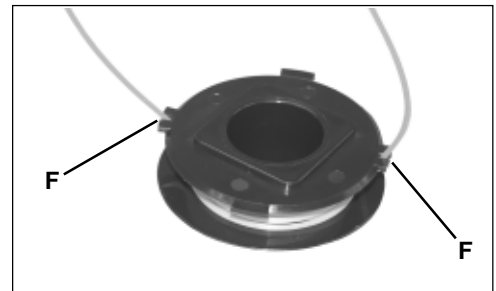

6. Thread line ends through housing eyelets (G) and place spool in housing against spring.

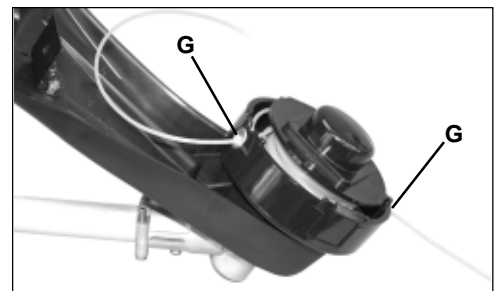

7. Align cover tabs with tab holes in housing and push cover on until tabs snap-lock into place.

8. Pull on both lines until they come free from notches in spool.

9. Index line out by pushing tap knob and trim line to cut-off knife length.



## SHARPENING METAL BLADES

Of the three styles of metal blades that are approved for use on the ECHO Brush Cutter, only the 8-tooth blade can be sharpened as an operator maintenance item. The clearing blade and 80 tooth blade require professional service.

Before sharpening, CLOSELY inspect blade for cracks (look at the bottom of each tooth and the center mounting hole closely), missing teeth, and bending. If ANY of these problems are discovered, replace the blade.

When sharpening a blade, always remove the same amount of material from each tooth to maintain balance. A blade that is not balanced will cause unsafe handling due to vibration, and can result in blade failure.

### Sharpening 8-tooth Blades

*Tool required:* Flat file (preferred).  
Electric grinder (if special care is used)  
Round (rat tail) file for gullet (radius)

#### **IMPORTANT**

If an electric grinder is used, use care not to overheat teeth. DO NOT allow tips/tooth to glow red or turn blue. DO NOT place blade in cooling water. This will change the temper of the blade and could result in blade failure.

1. File each tooth at a 30 degree angle a specific number of times, eg. 4 strokes per tooth. Work your way around the blade until all teeth are sharp.
2. DO NOT file the 'gullet' (radius) of the tooth with the flat file. The radius must remain. A sharp corner will lead to a crack and blade failure.
3. After sharpening teeth, check each tooth radius for evidence of a square (sharp) corner. Use the round (rat tail) file to renew the radius.

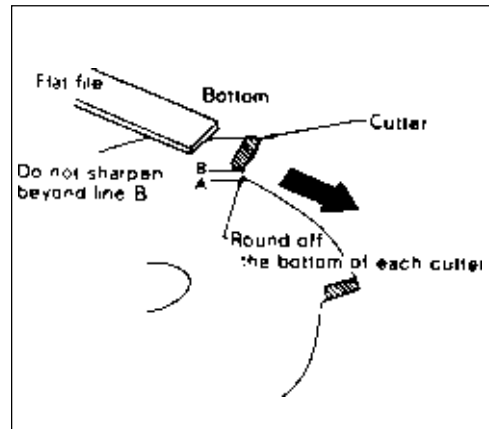
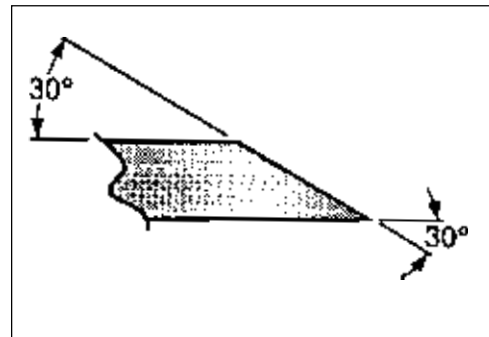
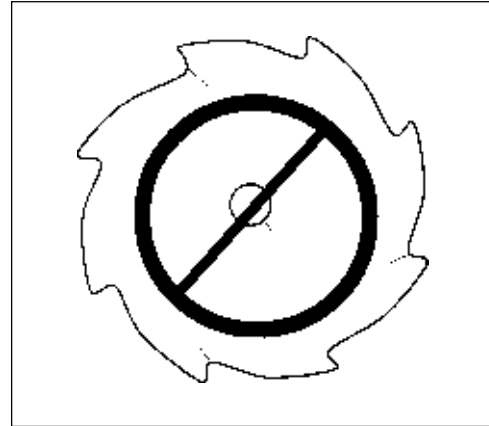

## TROUBLESHOOTING

ENGINE PROBLEM TROUBLESHOOTING CHART				
Problem	Check	Status	Cause	Remedy
Engine cranks - starts hard/ doesn't start	Fuel at carburetor	No fuel at carburetor	Fuel strainer clogged Fuel line clogged Carburetor	Clean or replace Clean or replace See your Echo dealer
	Fuel at cylinder	No fuel at cylinder	Carburetor	See your Echo dealer
		Muffler wet with fuel	Fuel Mixture too rich	Open choke Clean/replace air filter Adjust carburetor See your Echo dealer
	Spark at end of plug wire	No spark	Stop switch off Electrical problem Interlock switch	Turn switch to ON See your Echo dealer See your Echo dealer
	Spark at plug	No spark	Spark gap incorrect Covered with carbon Fouled with fuel Plug defective	Adjust to .65mm (0.026 in.) Clean or replace Clean or replace Replace plug
Engine runs, but dies or does not accelerate properly	Air filter	Air filter dirty	Normal wear	Clean or replace
	Fuel filter	Fuel filter dirty	Contaminants/residues in fuel	Replace
	Fuel vent	Fuel vent plugged	Contaminants/residues in fuel	Clean or replace
	Spark Plug	Plug dirty/worn	Normal wear	Clean and adjust or replace
	Carburetor	Improper adjustment	Vibration	Adjust
	Cooling System	Excessive dirt/debris	Extended operation in dirty/dusty locations	Clean
	Spark Arrestor Screen	Screen cracked, plugged, or perforated	Normal wear	Replace
Engine does not crank	N/A	N/A	Internal engine problem	See your Echo dealer

**WARNING**  **DANGER**

Fuel vapors are **extremely** flammable and may cause fire and/or explosion. **Never** test for ignition spark near an open spark plug opening, otherwise serious personal injury may result.

## STORAGE

### WARNING DANGER

During operation the muffler or catalytic muffler and surrounding cover become hot. Always keep exhaust area clear of flammable debris during transportation or when storing, otherwise serious property damage or personal injury may result.

### *Long Term Storage (over 30 days)*

Do not store your unit for a prolonged period of time (30 days or longer) without performing protective storage maintenance which includes the following:

1. Store unit in a dry, dust free place, out of the reach of children.

### WARNING DANGER

Do not store in enclosure where fuel fumes may accumulate or reach an open flame or spark.

2. Place the stop switch (A) in the "STOP" position.
3. Remove accumulation of grease, oil, dirt and debris from exterior of unit.
4. Perform all periodic lubrication and services that are required.
5. Tighten all the screws and nuts.
6. **Drain** the fuel tank **completely** and pull the recoil starter handle several times to remove fuel from the carburetor.
7. Remove the spark plug and pour 7 cc (1/4 oz.) of fresh, clean, two-stroke engine oil into the cylinder through the spark plug hole.
  - A. Place a clean cloth over the spark plug hole.
  - B. Pull the recoil starter handle 2-3 times to distribute the oil inside the engine.
  - C. Observe the piston location through the spark plug hole. Pull the recoil handle slowly until the piston reaches the top of its travel and leave it there.
8. Install the spark plug (do not connect ignition cable).

**NOTES**

# SERVICING INFORMATION

## PARTS

Genuine ECHO Parts and ECHO REPOWER™ Parts and Assemblies for your ECHO products are available only from an Authorized ECHO Dealer. When you do need to buy parts **always** have the Model Number and Serial Number of the unit with you. You can find these numbers on the engine housing. For future reference, write them in the space provided below.

ModelNo. \_\_\_\_\_ S.N. \_\_\_\_\_

## SERVICE

Service of this product during the warranty period must be performed by an Authorized ECHO Service Dealer. For the name and address of the Authorized ECHO Service Dealer nearest you, ask your retailer or call: 1-800-432-ECHO (3246). Dealer information is also available on our Web Site. When presenting your unit for Warranty service/repairs, proof of purchase is required.

## ECHO CONSUMER PRODUCT SUPPORT

If you require assistance or have questions concerning the application, operation or maintenance of this product you may call the ECHO Consumer Product Support Department at 1-800-673-1558 from 8:30 am to 4:30 pm (Central Standard Time) Monday through Friday. Before calling, please know the model and serial number of your unit to help your Consumer Product Support Representative.

## WARRANTY REGISTRATION

You may register your Echo equipment using the warranty registration card or register on-line at [www.echo-usa.com](http://www.echo-usa.com). Registering provides a direct link between you and ECHO if we find it necessary to contact you.

## ADDITIONAL OR REPLACEMENT MANUALS

**Safety Manuals** in English/Spanish or English/French are available free of charge from your ECHO dealer, or online at [www.echo-usa.com](http://www.echo-usa.com).

**Operator's and Parts Manuals** are available by:

- Downloading free from [www.echo-usa.com](http://www.echo-usa.com)
- Purchasing from your Echo Dealer.
- Sending a check or money order for \$2.00 per Parts Catalog or \$1.50 per Operator's Manual made payable to ECHO, INCORPORATED. State on a sheet of paper the model number and serial number of the ECHO unit you have, part number of the manual (if known), your name and address and mail to address below.

**Safety Videos** are available from your Echo dealer. A \$5.00 shipping charge is required for each video.

### Available Parts Catalog Parts Lists

SRM-340

Sserial Number 03001001 - 03999999

Part Number 99922203559

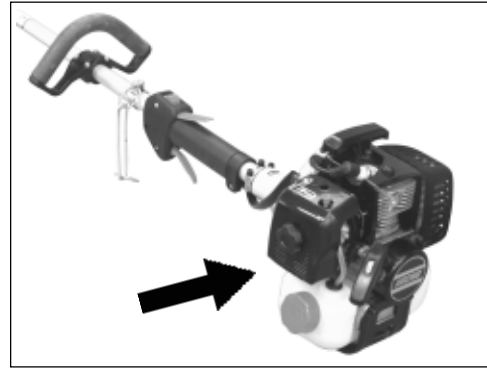

**DEALER?  
CALL  
1-800-432-ECHO  
OR  
[www.echo-usa.com](http://www.echo-usa.com)**

**CONSUMER PRODUCT  
SUPPORT  
1-800-673-1558  
8:30 - 4:30 MON - FRI C.S.T.**

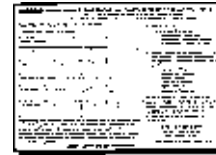

**ECHO**  
ECHO, INCORPORATED  
400 OAKWOOD ROAD  
LAKE ZURICH, IL 60047-1564  
[www.echo-usa.com](http://www.echo-usa.com)